



Submersible Sewage Pumps
Channel Impeller

B



Tsurumi B-series, the basic sewage pumps with channel foreign matter-related trouble. Years of know-how are built

Cable Entry

Every cable has an anti-wicking block at the cable entry section on the pump. This mechanism is such that a part of each conductor is stripped back and the part is sealed by molded rubber or epoxy potting which has flowed in between each strand of the conductor. This unique feature prevents wicking along the strand of the conductor itself.

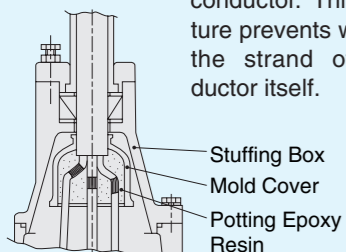

Motor

The motor is a dry-type, squirrel-cage induction motor, housed in a watertight casing, and conforms to insulation classes B, E or F. In each of these insulation classes, all standard pumps can be used in ambient temperatures up to 40°C.

Mechanical Seal

The mechanical seal with two seal faces containing silicon carbide (SiC) is equipped with the oil chamber. The advantages of the seal are two-fold, it eliminates spring failure caused by corrosion, abrasion or fouling which prevents the seal faces from closing properly, and prevents loss of cooling to the lower seal faces during run-dry conditions which causes the lower seal faces to fail.

Oil Lifter (Patented)

The Oil Lifter was developed as a lubricating device for the mechanical seal. Utilizing the centrifugal force of the shaft seal, the Oil Lifter forcibly supplies lubricating oil to the mechanical seal and continues to supply the oil to the upper seal faces even if lubricant falls below the rated volume. This amazingly simple device is not only reliably lubricates and cools down, but also retains the stable shaft seal effect and extends the inspection term.

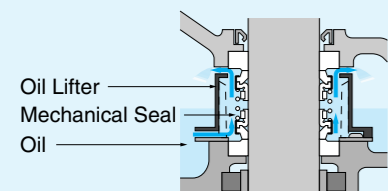

Motor Protector

Each pump up to 7.5kW as standard has a built in auto-cut, self-resetting Circle Thermal Protector (CTP). Integrated in the motor housing, the CTP directly cuts the motor circuit if excessive heat builds up or an overcurrent caused by an electrical or mechanical failure occurs.

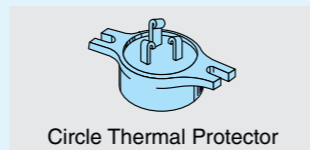

A Miniature Thermal Protector (MTP) is embedded in each winding of the motor. These MTPs are connected in series, and their wires are led out of the motor. Should the winding temperature rise to the actuating temperature, the bimetal strip opens to cause the control panel to shut the power supply.

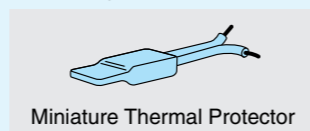

Shaft

The high-tensile stainless steel shaft used on all pumps is designed to have adequate strength for the transmission of the full load. It is supported by C3 type, high-quality, deep-groove ball bearings.

Impeller

The impeller is semi-open or shrouded type with one or two vanes. It has a wide channel extending from inlet to exit, which allows the pump to pass the solid matters from inflow to discharge with minimal blockage.



Leakage Sensor

A stainless steel, electrode type leakage sensor is standardized for large pumps of 22kW or over (excluding some models). It senses water incursion into the oil chamber and brings the pump to a halt with the help of a control panel.



MODEL NUMBER DESIGNATION

100	B	A	6	3.7	S	H
Discharge bore in mm	Name of the series	Operation sub code	Number of poles of the motor	Rated motor output in kW	Phase	Sub code for pumping head
		None : None automatic operation A : Automatic operation W : Auto-alternation operation			None : Three-phase S : Single-phase	H : High head L : Low head

impeller that minimize clogging, winding, and other into very part of the pumps for highly reliable operation.

GUIDE RAIL FITTING SYSTEM

The guide rail fitting system connects the pump to and from the piping easily just by lowering and hoisting the pump, allowing easy maintenance and inspection without the need to enter the sump.

Pump models used in combination with the guide rail fitting system can be identified by the prefix "TOS or TO" and "TS". Refer to standard specifications for availability and model numbers.

TOS and TO

The TOS/TO is the standard guide rail fitting system made of cast-iron and is compatible with cast-iron pumps.



TS

This compact guide rail fitting system is ideal for installing in prefabricated lift stations. Its discharge flange is compatible with major flange standards including ANSI 150lb, BS PN10 and DIN PN10.



DRY PIT MODEL

The advantage of dry pit model is that it will not be damaged by flooding, as it is constructed with a submersible pump.

Tsurumi can provide the dry pit model as option for the whole range of B-series pumps.

The water jacket covers whole part of the motor. It efficiently cools the motor for continuous operations.



AUTO-ALTERNATION MODEL

The auto-alternation model is used along with an automatic model. The combinational use of these two pumps enables each pump to operate alternately without control panel.

The auto-alternation model has three floats and can be identified by the suffix "W". Refer to standard specifications for availability and model numbers. It is available in the same output range of the automatic pumps.

How the Auto-alternation Model Works

● Operation is enabled by merely connecting the power supply.

Primary Operation

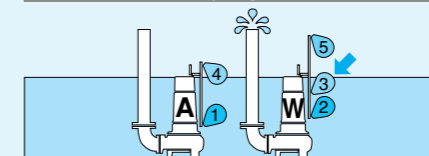

1 Float 3 operates, and pump W starts to discharge water.

Secondary Operation

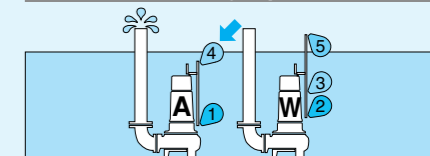

1 Start float 4 of pump A operates to start water discharge.

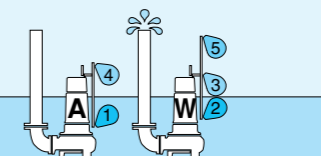

2 Water is discharged (water level falls).

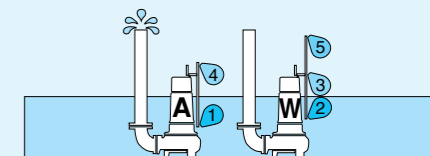

2 Water is discharged (water level falls).

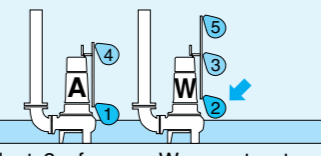

3 Stop float 2 of pump W operates to end water discharge. At this time, alternation start float 3 of pump W rests for one discharge operation.

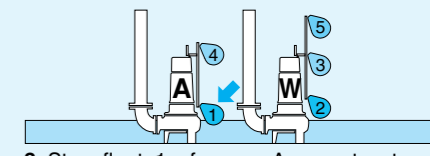

3 Stop float 1 of pump A operates to end water discharge. At the same time, start float 3 of pump W becomes ready for operation.

* Primary operation and secondary operation are repeated alternately.

* Both primary and secondary operations are performed simultaneously when water has risen to an abnormal level.

AUTOMATIC MODEL

The automatic model has an integral control circuit and two float switches that operate at a low voltage. It operates automatically in response to the change in water levels. As it has a Circle Thermal Protector (CTP) integrated into the motor to protect the motor from overload or overheating, it is not required to provide an extra motor protection circuit in the starter panel.

This model can be identified by the suffix "A". Refer to the standard specifications for availability and model numbers.

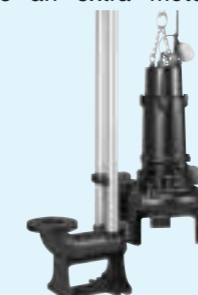

B-series is the Basic of Submersible Sewage Pumps using for all the society fundamentals. Durable and High Quality Products can be used for various kinds of field.



B-series pumps are working in many sewage treatment plants throughout Japan because of their excellent reputations. As durable motor is tough enough against frequent ON/OFF, automatic unattended operation by central control is available.



As it is silent during operation owing to its underwater operation, B-series pumps are often used at the basement of buildings in the city area.

Even if the condition is very severe, sewage pumps are required to have high and steady performance. Tsurumi B-series pumps can give a solution for this problem.



While in overseas, Tsurumi has a lot of sales records with B-series pumps, too. Several inventions adopted by the idea seeking better handling produces ease of maintenance and repair for users comparing to other manufacturers. Because of this, Tsurumi pumps have good reputation as the most intimate pump in the world.



In the shipyard, B-series pumps, which are operated by fully-automatic control, work for level control and dry up. For sea water, sacrificial anodes are applied.



B-series pumps being used for a temporary installation during rainy season. It is used to pump up water of branch river to the main stream when the water level of main stream becomes higher than that of the branch river.



Enough absorption can not be expected in the city center where the ground is covered by concrete. Occasional flood occurs often when a local heavy rain comes. In such case, large capacity B-series pumps play an active role.



Because of its robust construction, B-series pumps are sometimes used for dewatering in construction site. Compact shape allows high portability comparing against the horizontal pump which requires a firm installation foundation work. In such case, some pump parts are changed its material into harder materials.

■ Performance Curves

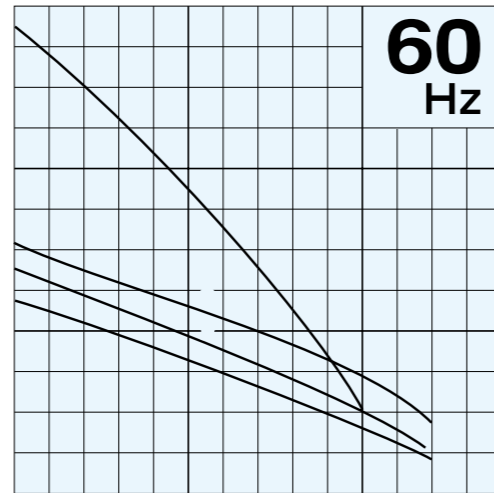
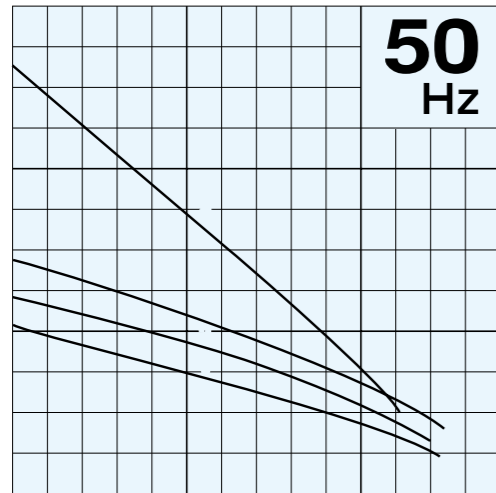

■ Standard Specifications

□		□		□ □		□ □ □	

*1 200~240V
*2 All weights excluding cable
Weights of guide rail fitting model excluding duckfoot bend

■ Dimensions

Free Standing

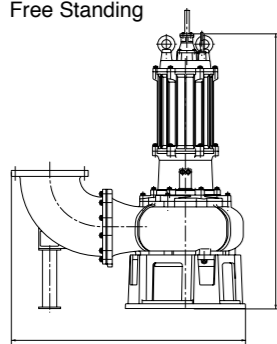

Guide Rail Fitting

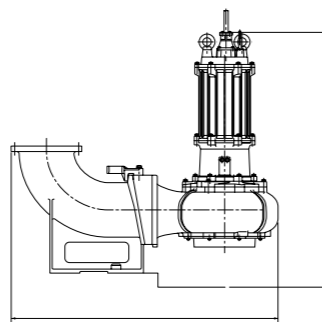

■ Performance Curves

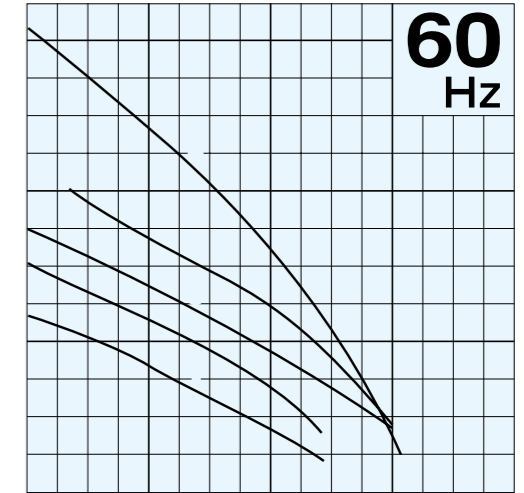
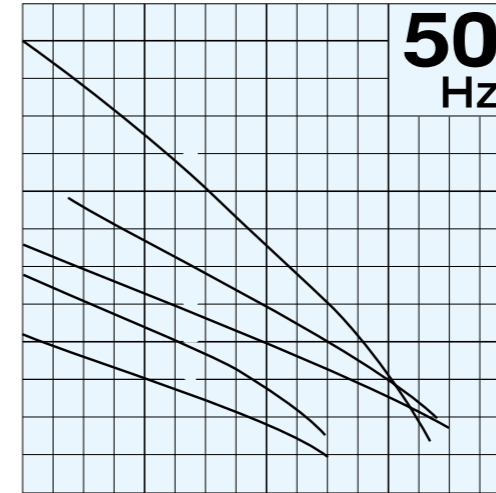

■ Standard Specifications

□		□		□ □		□ □ □	

*1 200~240V
*2 All weights excluding cable
Weights of guide rail fitting model excluding duckfoot bend

■ Dimensions

Free Standing

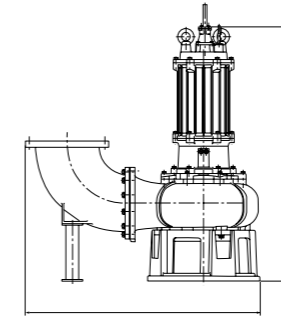

Guide Rail Fitting

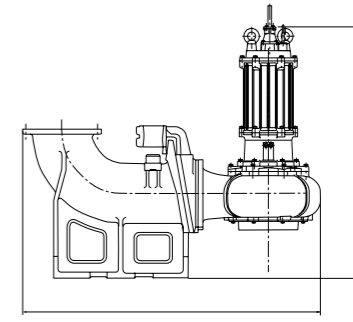

Performance Curves

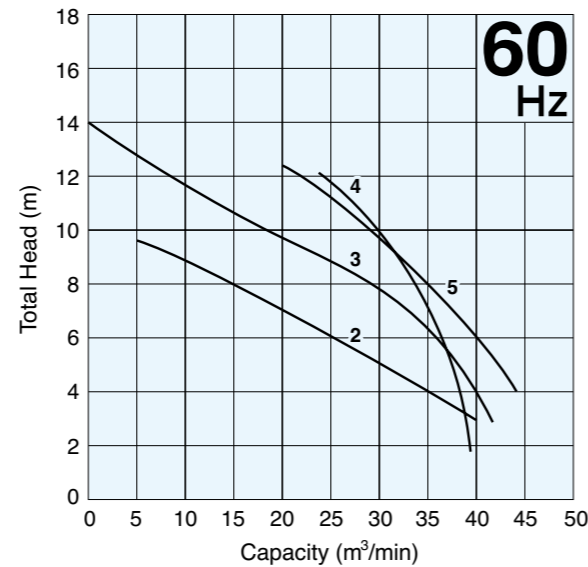
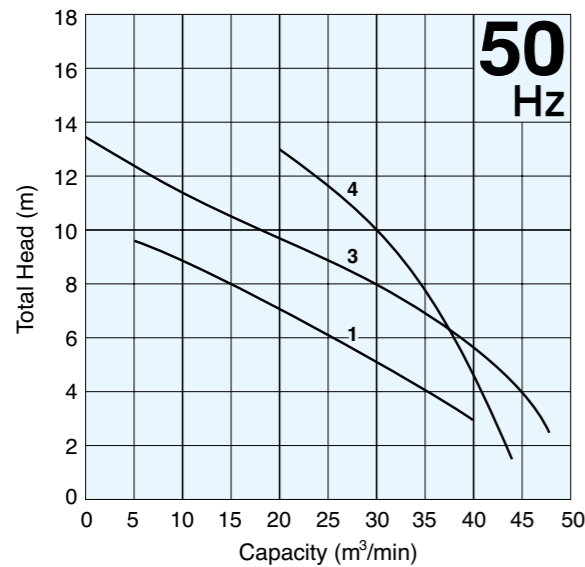

Standard Specifications

Curve No.	Discharge Bore mm	Model		Motor Output kW	Phase	Speed (S.S.) 50Hz/60Hz min ⁻¹	Starting Method	Solids Passage 50Hz/60Hz mm	Cable Length m	Cable Code	Dimensions L×H mm		Dry Weight* kg		Frequency
		Free Standing	Guide Rail Fitting								Free Standing	Guide Rail Fitting	Free Standing	Guide Rail Fitting	
1	500	500B1037	TO500B1037	37	Three	600/—	Star-Delta	225×100	10	K	2073×2081	2622×2183	2050	1950	50Hz only
2	500	500B1237	TO500B1237	37	Three	—/600	Star-Delta	225×100	10	K	2073×2081	2622×2183	2050	1950	60Hz only
3	500	500B855	TO500B855	55	Three	750/900	Star-Delta	175×140/ 175×80	10	K	2111×2077	2660×2225	2150	2050	50Hz/60Hz
4	500	500B675	TO500B675	75	Three	1000/1200	Star-Delta	130×120/ 130×100	10	K	2263×1987	2812×2152	2150	2050	50Hz/60Hz
5	500	500B875	TO500B875	75	Three	—/900	Star-Delta	190×80	10	K	2150×2694	2700×2644	2550	2450	60Hz only

* All weights excluding cable
Weights of guide rail fitting model excluding duckfoot bend

Dimensions

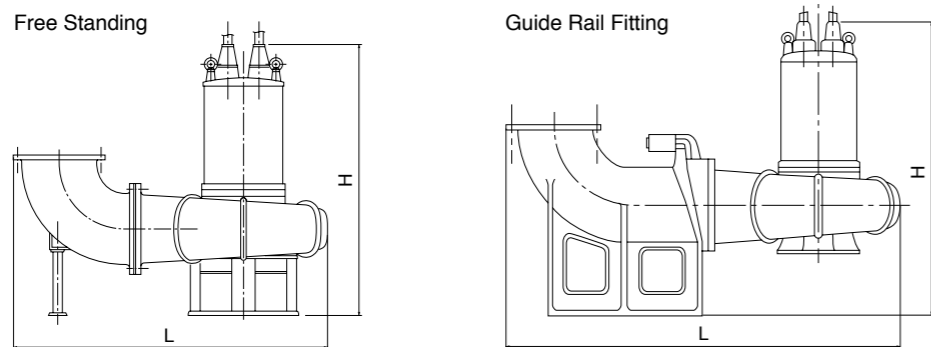

Performance Curves

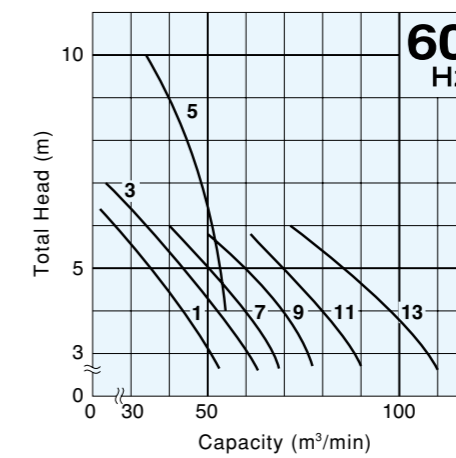
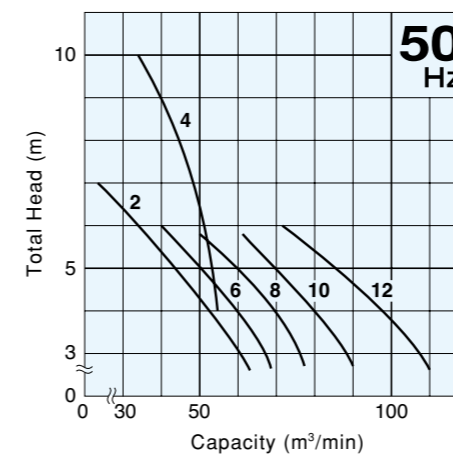

Dimensions

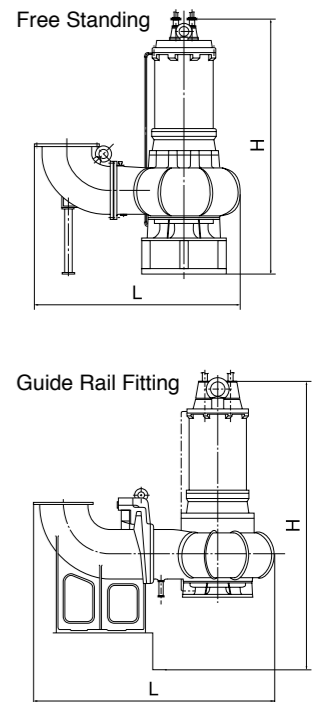

Standard Specifications

Curve No.	Discharge Bore mm	Model		Motor Output kW	Phase	Speed (S.S.) 50Hz/60Hz min ⁻¹	Starting Method	Solids Passage mm	Cable Length m	Cable Code	Dimensions L×H mm		Dry Weight* kg		Frequency
		Free Standing	Guide Rail Fitting								Free Standing	Guide Rail Fitting	Free Standing	Guide Rail Fitting	
1	600	600B1845	TO600B1845	45	Three	—/400	Star-Delta	280×90	10	K	2522×3100	3062×3100	5000	5200	60Hz only
2	600	600B1255	TO600B1255	55	Three	500/—	Star-Delta	220×100	10	K	2522×3100	3062×3100	3150	3350	50Hz only
3	600	600B1455	TO600B1455	55	Three	—/514	Star-Delta	220×100	10	K	2522×3100	3062×3100	3150	3350	60Hz only
4	600	600B1085	TO600B1085	85	Three	600/—	Star-Delta	210×85	10	K	2468×3100	3008×3100	3100	3300	50Hz only
5	600	600B1285	TO600B1285	85	Three	—/600	Star-Delta	210×85	10	K	2468×3100	3008×3100	3100	3300	60Hz only
6	700	700B1265	TO700B1265	65	Three	500/—	Star-Delta	300×85	10	K	2840×3560	3440×3660	4000	4400	50Hz only
7	700	700B1465	TO700B1465	65	Three	—/514	Star-Delta	300×85	10	K	2840×3560	3440×3660	4000	4400	60Hz only
8	700	700B1275	TO700B1275	75	Three	500/—	Star-Delta	300×85	10	K	2840×3560	3440×3660	4200	4600	50Hz only
9	700	700B1475	TO700B1475	75	Three	—/514	Star-Delta	300×85	10	K	2840×3560	3440×3660	4200	4600	60Hz only
10	800	800B1290	TO800B1290	90	Three	500/—	Star-Delta	300×90	10	L	3053×3790	3623×3790	5600	5800	50Hz only
11	800	800B1490	TO800B1490	90	Three	—/514	Star-Delta	300×90	10	L	3053×3790	3623×3790	5600	5800	60Hz only
12	800	800B14110	TO800B14110	110	Three	428/—	Star-Delta	310×90	10	L	3053×3790	3623×3790	5800	6000	50Hz only
13	800	800B16110	TO800B16110	110	Three	—/450	Star-Delta	310×90	10	L	3053×3790	3623×3790	5800	6000	60Hz only

* All weights excluding cable
Weights of guide rail fitting model excluding duckfoot bend

CABTYRE CABLE CODE REFERENCE

Single-phase

Code	No. of Cables	Cores × mm ²	Outer Dia. mm	Material
a	1	3 × 1.25	10.1	PVC
b	1	3 × 2.0	10.9	

Code	No. of Cables	Cores × mm ²	Outer Dia. mm	Material
D	1	4 × 3.5	14.1	Chloroprene Rubber
E	1	4 × 5.5	16.8	
F	3	4 × 3.5	14.1	
		3 × 3.5	12.9	
G	3	2 × 1.25	9.8	
		4 × 5.5	16.8	
J	3	3 × 5.5	15.2	Chloroprene Rubber
		2 × 1.25	9.8	
K	2	4 × 14	21.7	Chloroprene Rubber
		3 × 14	19.7	
		4 × 1.25	11.1	
K	2	3 × 38	35.8	Chloroprene Rubber
		1 × 22		
		3 × 2		
K	2	3 × 38	35.9	Chloroprene Rubber
		3 × 38		

Code	No. of Cables	Cores × mm ²	Outer Dia. mm	Material
L	2	3 × 60	45.7	Chloroprene Rubber
		1 × 22		
		3 × 2		
M	1	3 × 60	45.7	
		7 × 3.5		
N	1	2 × 2	24.4	
		7 × 5.5		
O	1	2 × 2	25.6	
		7 × 8		
P	3	4 × 14	21.7	Chloroprene Rubber
		3 × 14		
		2 × 1.25		
Q	3	4 × 22	28.8	Chloroprene Rubber
		3 × 22		
		3 × 22		
Q	3	4 × 1.25	11.1	PVC
		4 × 1.25		

Three-phase

Code	No. of Cables	Cores × mm ²	Outer Dia. mm	Material
A	1	4 × 1.25	11.1	PVC
B	1	4 × 2.0	11.8	
C	1	4 × 3.5	13.9	

TSURUMI OPTIONS

SPECIAL VERSION WITH GALVANIC CORROSION PROTECTION

In seawater, a material's resistance to corrosion can be seen clearly. When metals with different potentials are brought into contact in seawater, only the metal of lower potential corrodes. As the difference in potential increases, the metal of lower potential corrodes faster. As an option, Tsurumi can supply pumps with parts made of higher electric potential metal as the sacrificial anode.

SPECIAL VERSION FOR HIGHER TEMPERATURE LIQUID

Standard pumps are designed for continuous running at the maximum ambient temperature of 40°C. In addition to these, Tsurumi can provide pumps for operation at higher liquid temperatures upon request. Refitting for operation at higher temperatures involves modification of not only the insulation of motor windings but also several components.

Two high-temperature operating models are available - the Rank 60 for operation in liquids up to 60°C and the Rank 90 for operation in liquids up to 90°C. Consult your dealer for more details. (These special versions are not available for some pump models.)

SPECIAL VERSION WITH NON-STANDARD MATERIALS

Tsurumi can also provide you with pumps with essential components such as the impeller, pump casing and the suction cover made of non-standard materials. Select from stainless steel, chromium iron and bronze to suit your specific requirements. Consult your dealer for more details.

SPECIAL ACCESSORIES

FLOAT SWITCHES

Tsurumi offers two types of float switches (liquid level sensors). A micro-switch is incorporated in both types.

Model MC-2 is a heavy-duty type float switch with a shock absorber. Having equipped with a high grade micro switch, the MC-2 assures trouble-free operation in the liquid containing much suspended solids and floating scum. Either of the two contacts, normally-open or normally-close, can be selected as required.

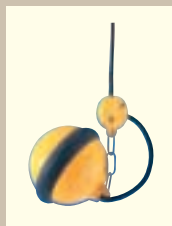

Model RF-5 is an economy type float which can detect upper/lower-limit water levels with single float. The snap on-off action ensures stable operation in clean or waste water containing suspended solids or oil and fat.



We reserve the right to change the specifications and designs for improvement without prior notice.

TSURUMI
MANUFACTURING CO., LTD.

Your Dealer